



Revisionsi
Piegatrici
Cesoi



by



SPEED GRIP

SISTEMI **PNEUMATICI** PER IL CAMBIO RAPIDO DEGLI UTENSILI SUPERIORI



- ✓ utilizzo degli utensili STANDARD senza doverli modificare
- ✓ inserimento ed estrazione frontale e senza sforzo degli utensili di qualsiasi lunghezza
- ✓ nessuna modifica da effettuare sulla pressa piegatrice
- ✓ applicabile ad ogni tipo di macchina
- ✓ pieno rispetto delle normative CE di sicurezza
- ✓ **risparmio dei tempi di attrezzaggio macchina pari all' 80% rispetto ai sistemi manuali con viti**

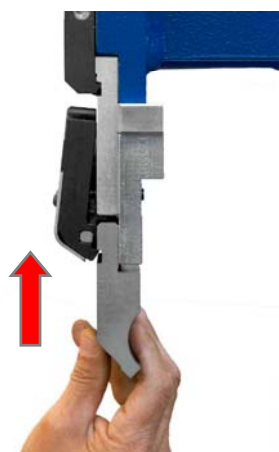

INSERIMENTO
FRONTALE

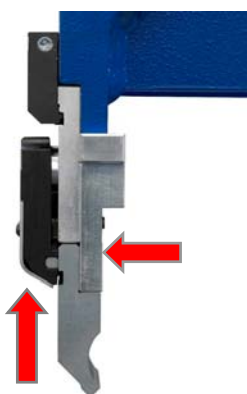

SOLLEVAMENTO AUTOMATICO
E RICHIAMO IN BATTUTA

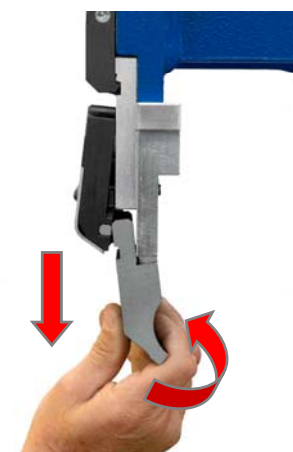

FACILE ESTRAZIONE
FRONTALE

3 MODELLI DISPONIBILI (3 varianti di passaggio dell'aria tra i moduli di bloccaggio):

- ✓ **SPEED GRIP 13131-F** (con tubo flessibile)
- ✓ **SPEED GRIP 13131** (con tubo telescopico)
- ✓ **SPEED GRIP 13131-STAR** (con l'innovativo sistema di trasmissione STAR SYSTEM)



Revisoni
Pieghatrici
Cesoie



SPEED GRIP FLEX

TUBO FLESSIBILE alloggiato in posizione protetta che permette un ampio movimento laterale dei moduli

Cod. 13131 - F

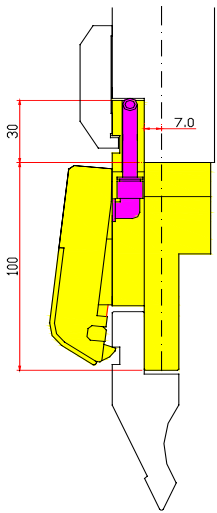

INFILAMENTO FRONTALE

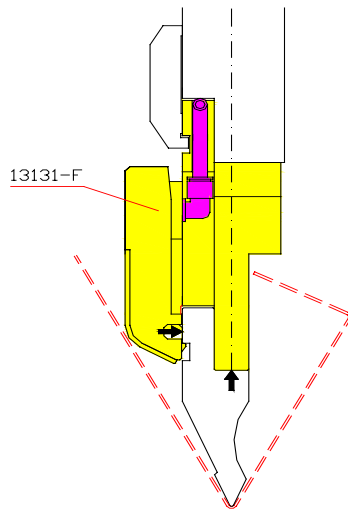

SOLLEVAMENTO
e BLOCCAGGIO

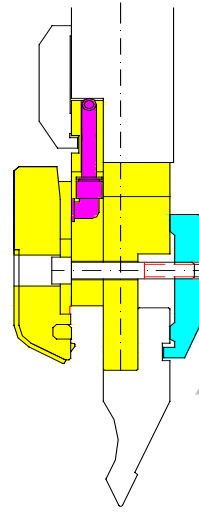

staffa manuale 11008
con avvntamento
frontale (opzionale)

UTENSILE
ROVESCiato

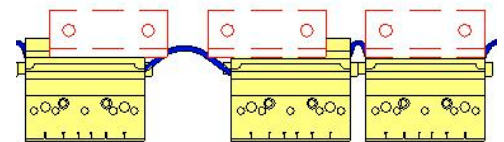

fino a 110mm

SPEED GRIP

TUBO TELESCOPICO brevettato che permette un ampio movimento laterale dei moduli

Cod. 13131

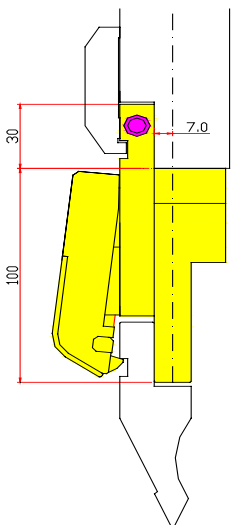

INFILAMENTO FRONTALE

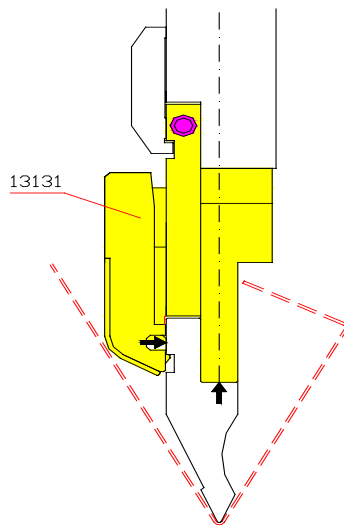

SOLLEVAMENTO
e BLOCCAGGIO

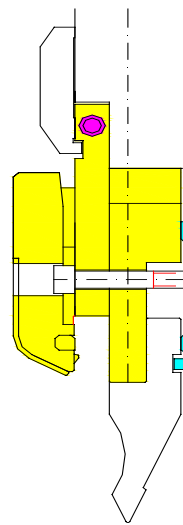

staffa manuale 11008
con avvntamento
frontale (opzionale)

UTENSILE
ROVESCiato

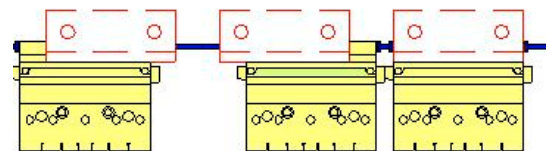

fino a 110mm

SPEED GRIP STAR

Innovativo sistema STAR che permette di rimuovere in modo semplice e immediato uno o più moduli senza interrompere la linea di lavoro

STAR SYSTEM

STAR CLAMPING

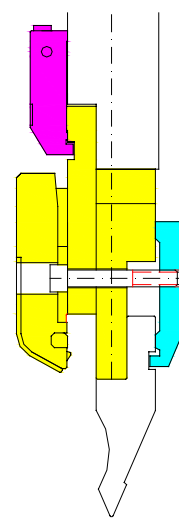
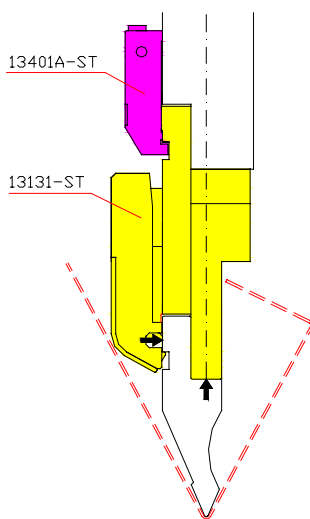
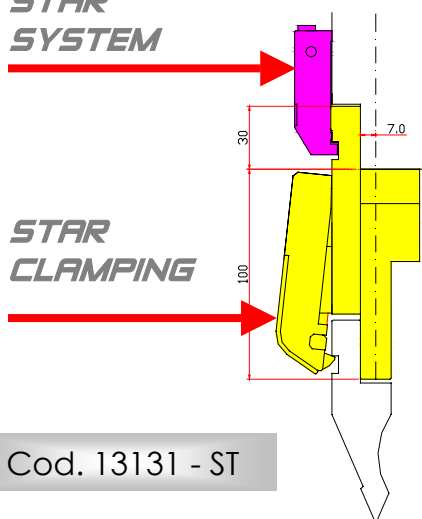

staffa manuale 11008
con avviteamento
frontale (opzionale)

Cod. 13131 - ST

INFILAMENTO FRONTALE

SOLLEVAMENTO
e BLOCCAGGIO

UTENSILE
ROVESCiato

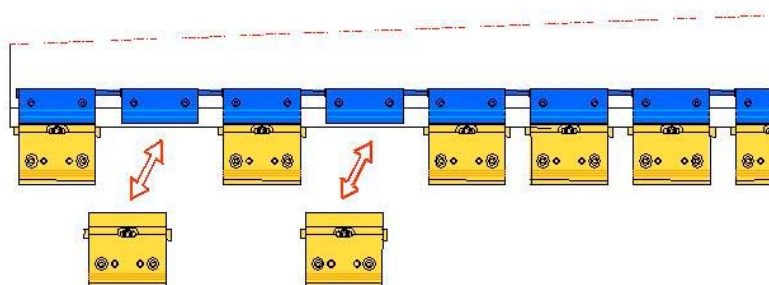

NESSUN TUBO DI COLLEGAMENTO
COMPLETA LIBERTA'



UNICO
AL MONDO

